

*realsport.ch*

# **WORKOUT & PARKOUR**



 **realsport**



Fondée en 1992, RealSport est la réunion de connaissances acquises depuis 1958 dans le domaine de l'aménagement de sport et de loisirs.

RealSport innove et fournit un guichet unique pour la construction de centres sportifs ou ludiques. De la planification jusqu'à la réception de l'ouvrage, vous n'avez qu'un seul interlocuteur capable de réaliser l'ensemble des prestations.

RealSport est le leader en Suisse, le groupe est entièrement dédié au marché de la construction sportive. L'entreprise est considérée comme un acteur incontournable dans son domaine. Les compétences d'étude et de planification permettent à l'entreprise d'accompagner clubs et collectivités pour le développement des projets.

RealSport c'est aujourd'hui 300 ingénieurs, techniciens, dessinateurs, employés de commerce, contremaîtres, ouvriers spécialisés et apprenants qui ont contribué à la réalisation de plusieurs milliers d'objets à ce jour.



## INDOOR

Sol sportif Indoor  
Fitness  
Squash  
Sol de danse, d'escrime  
Salle de boxe  
Parquet sportif  
Sol polyuréthane  
Rénovation de sol sportif  
Service réparations 24h/24 h  
Chauffage au sol  
Protection de sol sportif  
Concept d'entretien  
Planification  
etc...

## OUTDOOR

Terrain de football naturel  
Terrain de foot synthétique  
Court de tennis  
Piste d'athlétisme  
Place multisport  
Beach-volley et sports de plage  
Piste finlandaise  
Parcours de golf  
Place de jeux  
Street Workout  
Inline Hockey  
Gazon artificiel d'agrément  
Arrosage automatique  
Eclairage sportif  
Clôture  
Toutes fournitures d'engins sportifs  
Patinoire de glace naturelle  
Patinoire de glace synthétique  
etc...

## BUILDING

Architecture textile  
Couverture de préau  
Salle de sport en architecture textile  
Tribune de stade  
Bâtiment en ossature bois  
Vestiaire  
Buvette  
Locaux de rangement  
Etude et planification  
etc...



# Championnat Suisse 2016 de Streetworkout



Bern, 2016



Bern, 2016



Bern, 2016



[www.swissstreetworkout.ch](http://www.swissstreetworkout.ch)



Place Chaudron 9, Lausanne, Suisse, 2014



Av. de la Sallaz 36, Lausanne, Suisse, 2015



Av. de Boveresses 60, Lausanne, Suisse, 2014



Bex Suisse, 2015



Bex Suisse, 2015



Préverenge, 2016



Bulle Suisse, 2016

All KENGURU PRO street workout fields are built in a modern style

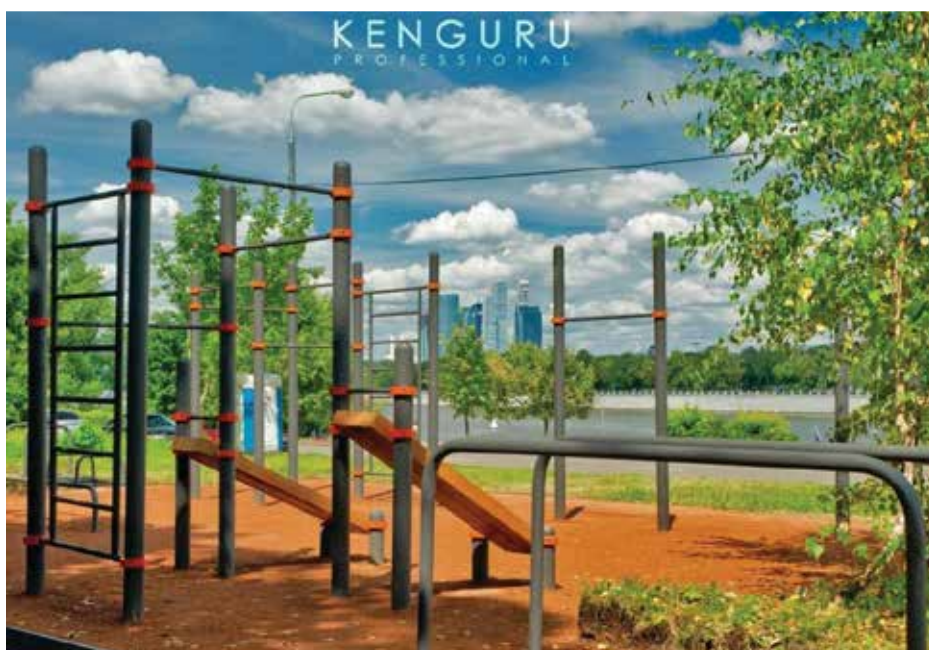



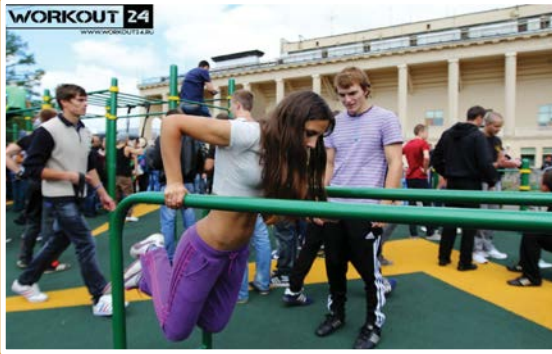

Such sports fields are suitable for people of different ages at any time. Creation of STREET WORKOUT sports fields promote healthy lifestyle and develop large scale street sports and create the basis for new healthy and active generation



Série K  
Modules de Street Workout à  
sceller dans des socles en béton

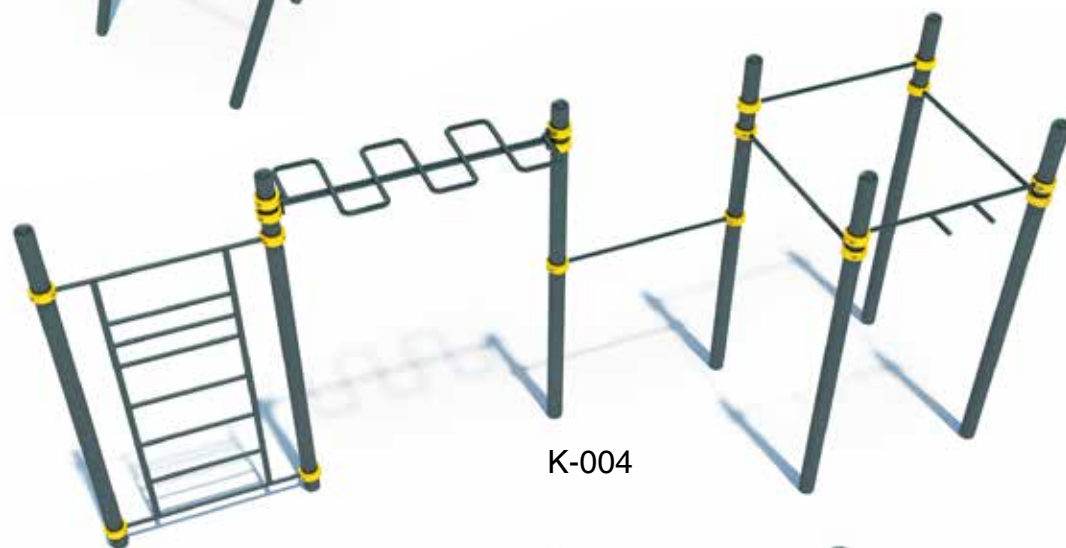
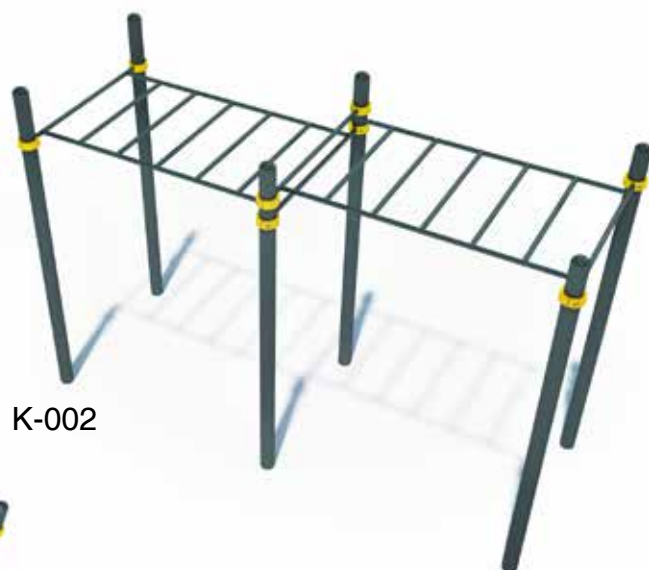

# WORKOUT

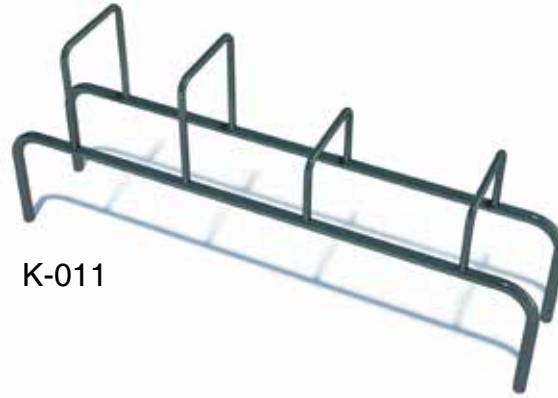
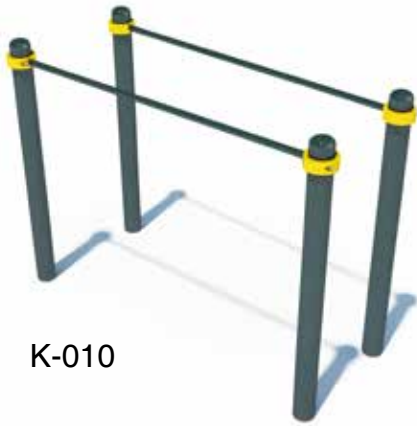
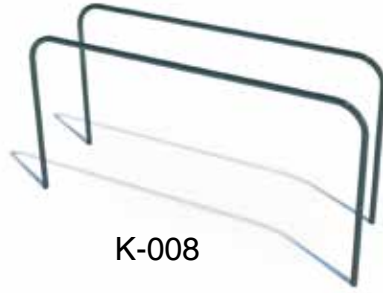

## Série K

Modules de Street Workout à sceller dans des socles en béton

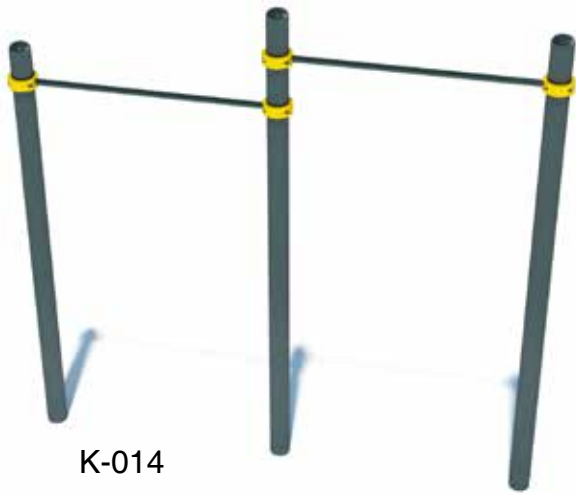

K-014



K-015



K-016



K-017



K-018



K-019

# WORKOUT



K-020



K-021

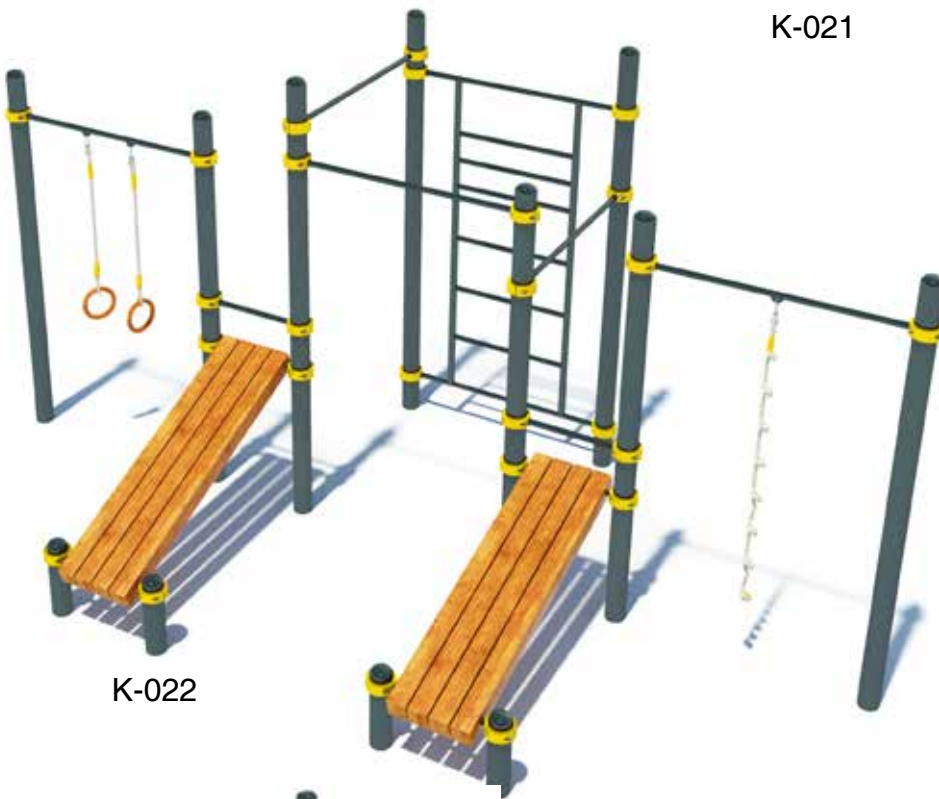

K-022



K-023



K-024

## Série K

Modules de Street Workout à sceller dans des socles en béton

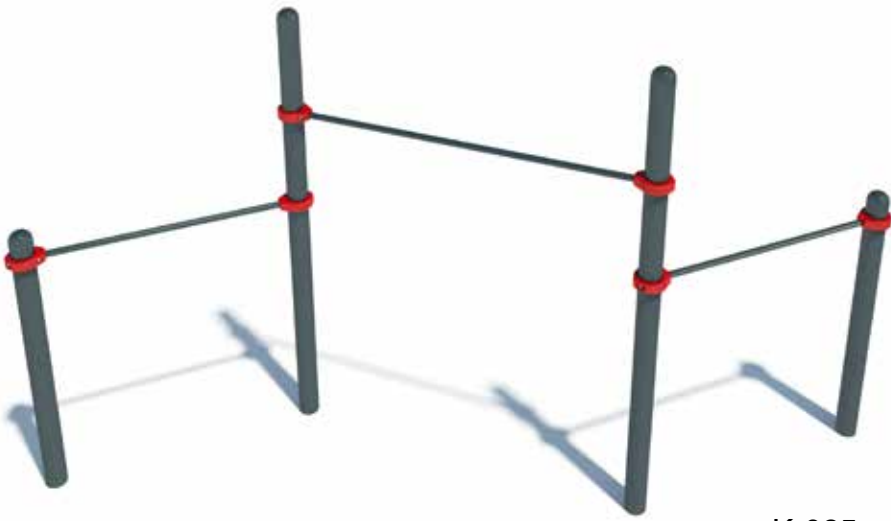

K-025

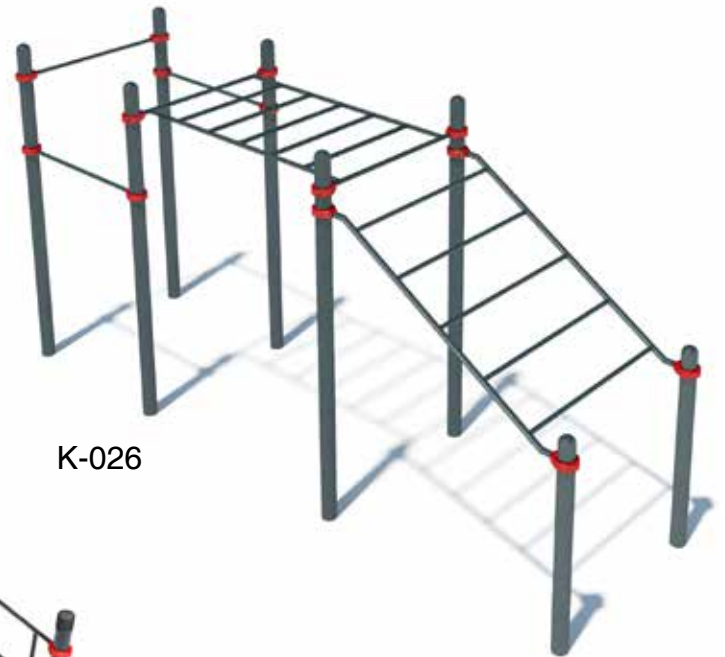

K-026

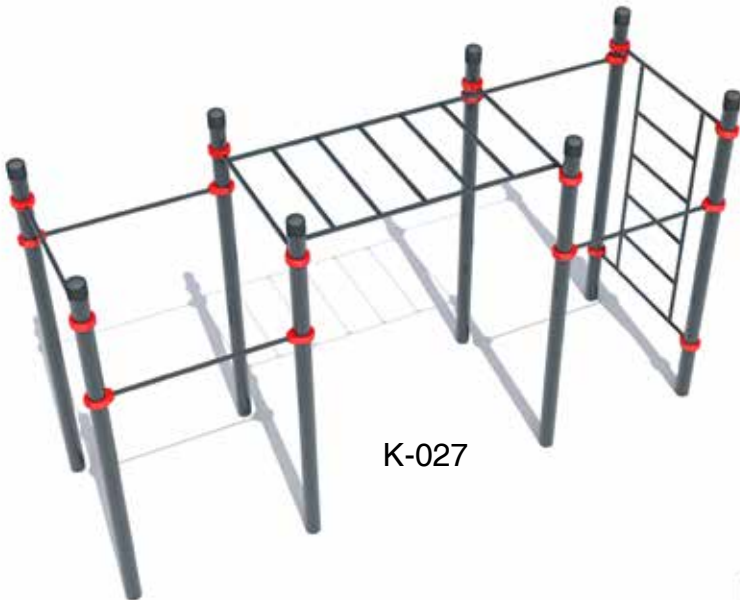

K-027



K-028

# WORKOUT

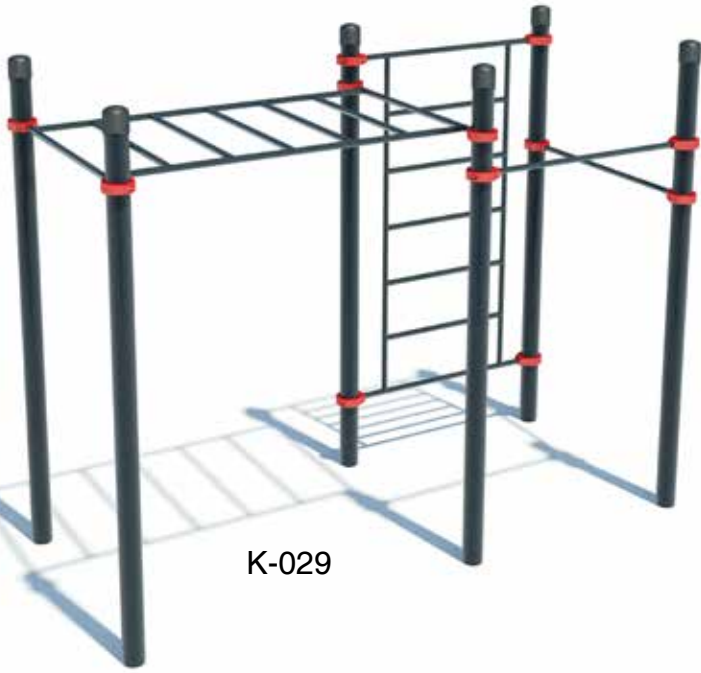

K-029

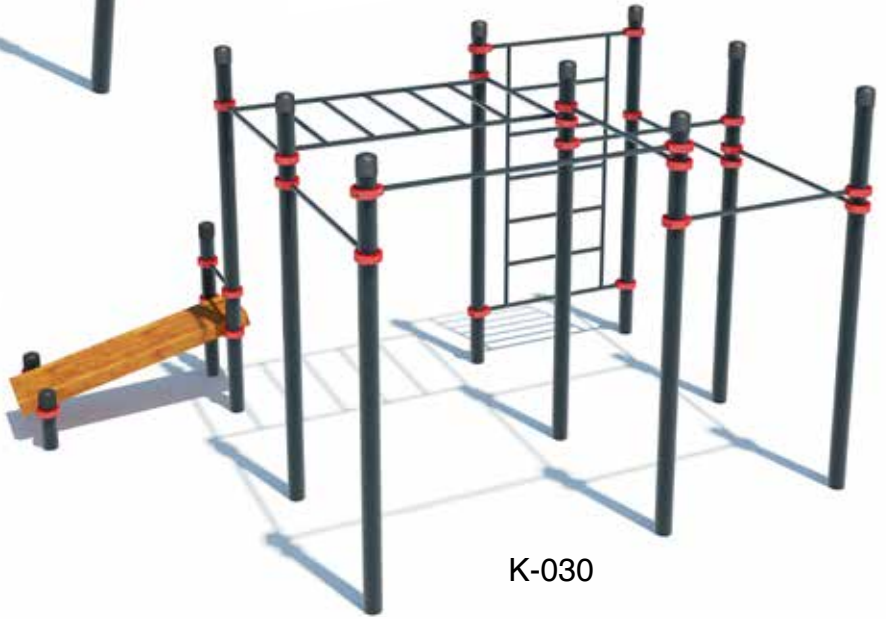

K-030

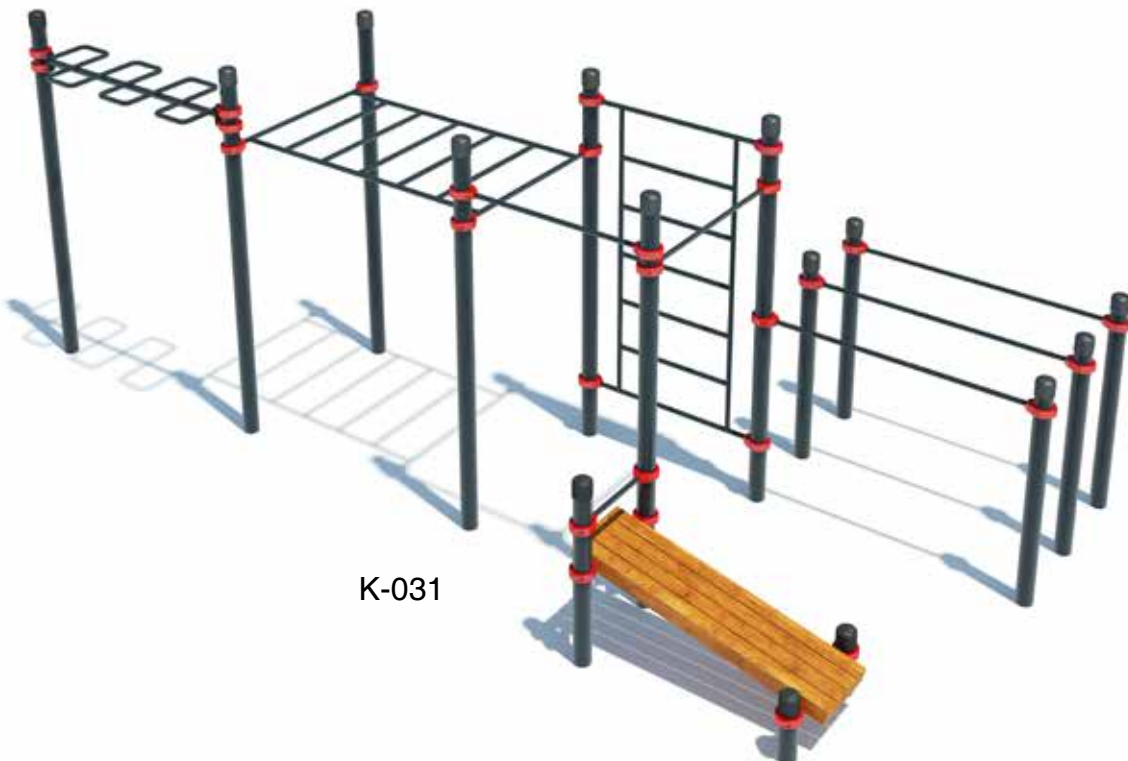

K-031

## Série D

Modules de Street Workout  
auto-portant Indoor ou Outdoor,  
pas besoins de socles béton

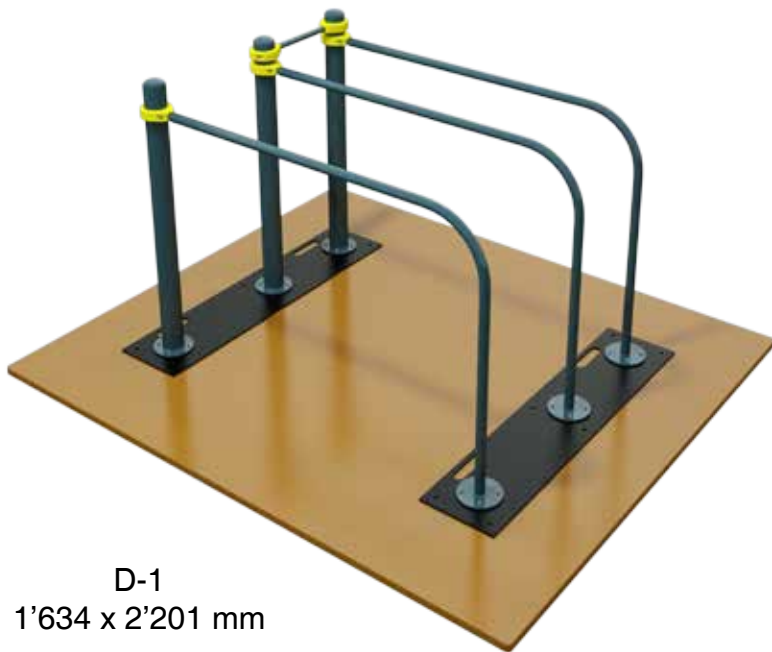

D-1  
1'634 x 2'201 mm



D-2  
1'634 x 1'651 mm



D-3  
2'184 x 1'651 mm

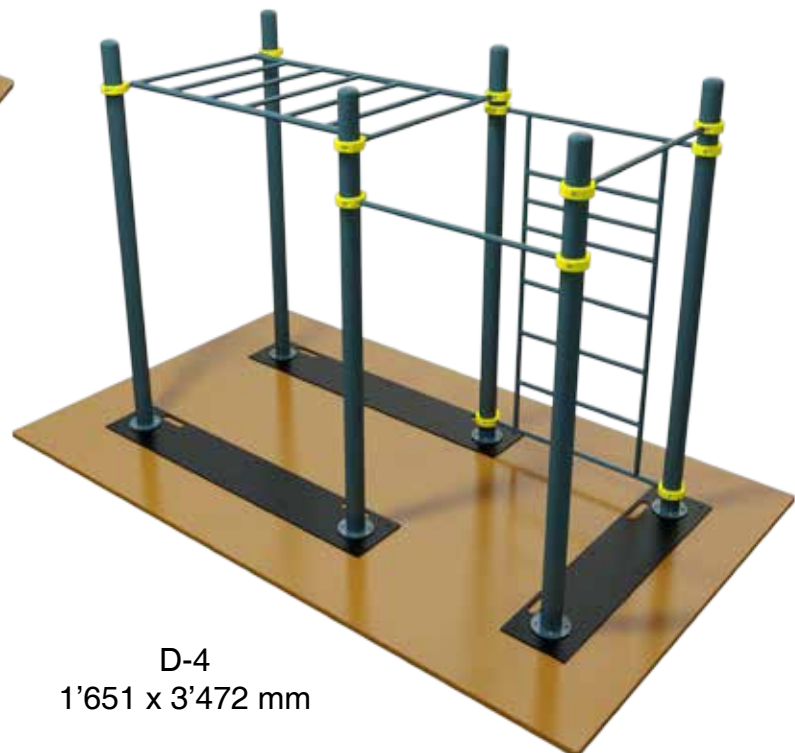

D-4  
1'651 x 3'472 mm



# WORKOUT



D-5  
1'651 x 4'211 mm

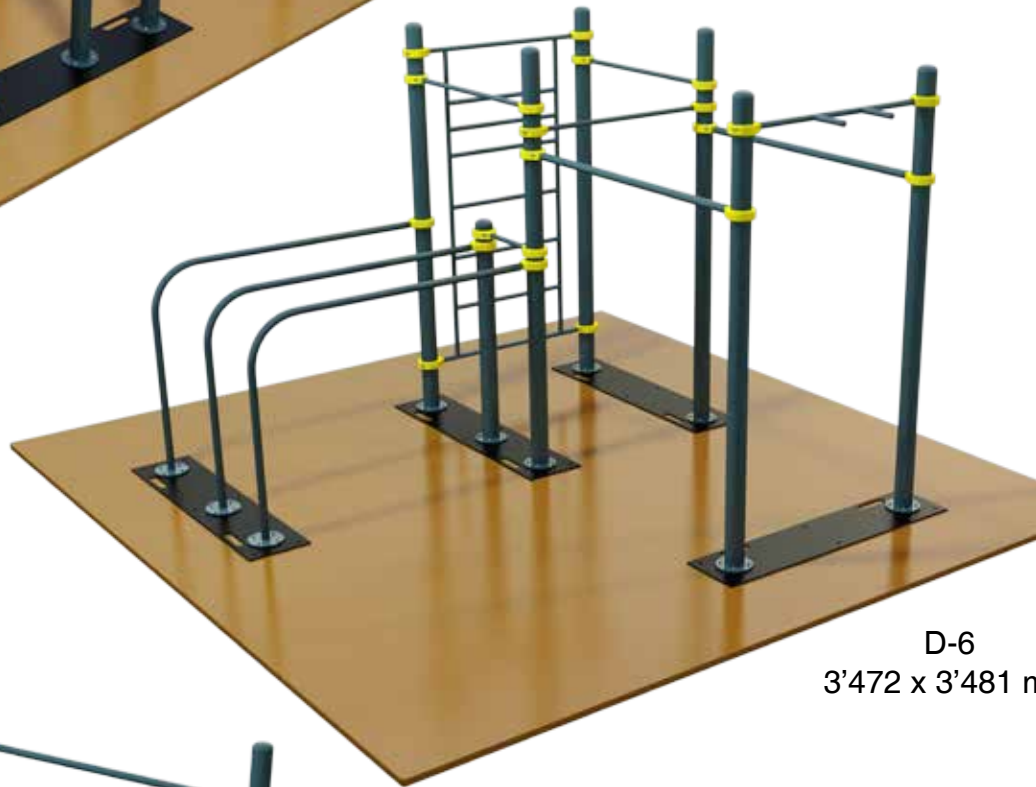

D-6  
3'472 x 3'481 mm



D-7  
2'201 x 4'752 mm

**Série D**  
**Modules de Street Workout**  
**auto-portant Indoor ou Outdoor**

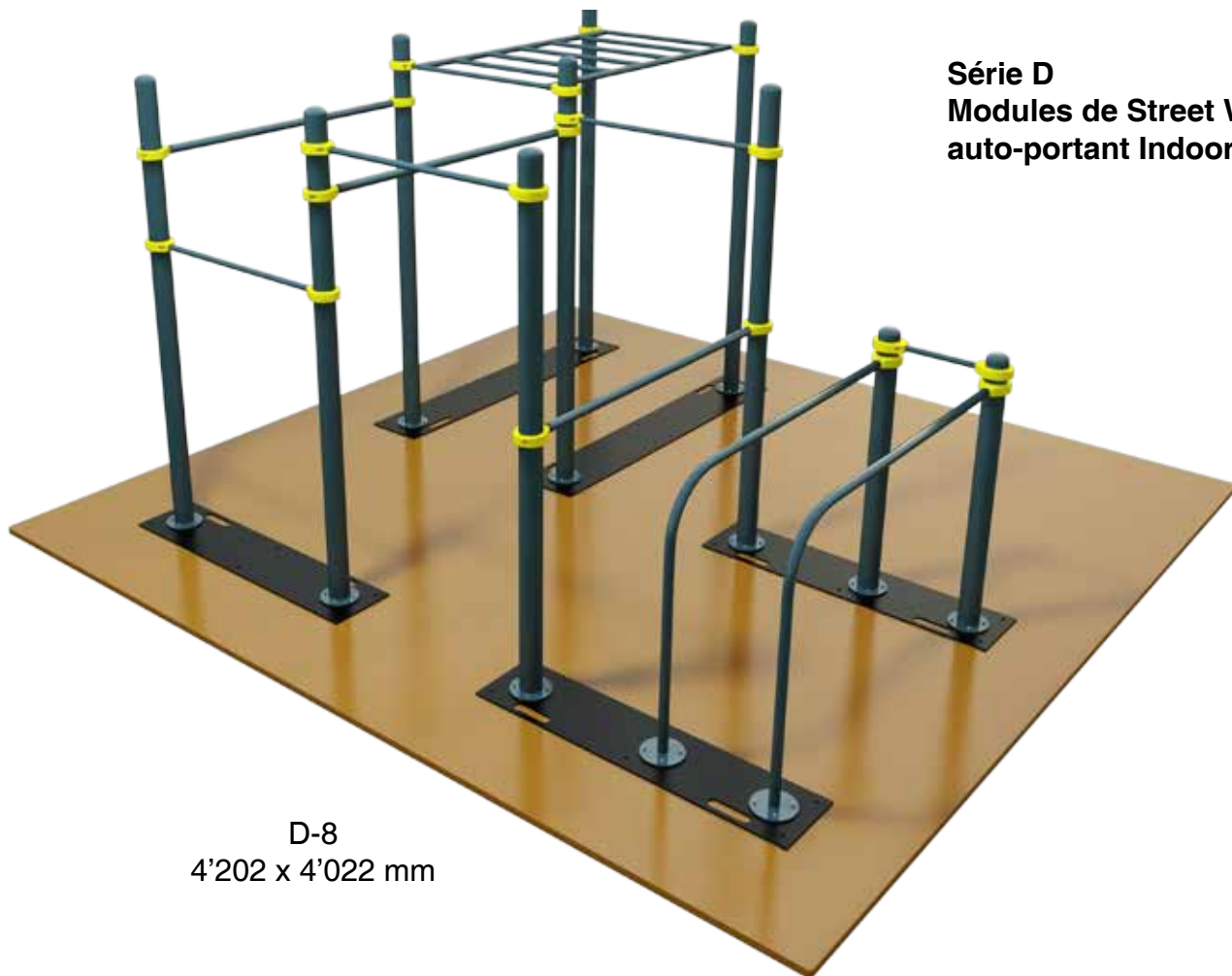

D-8  
4'202 x 4'022 mm

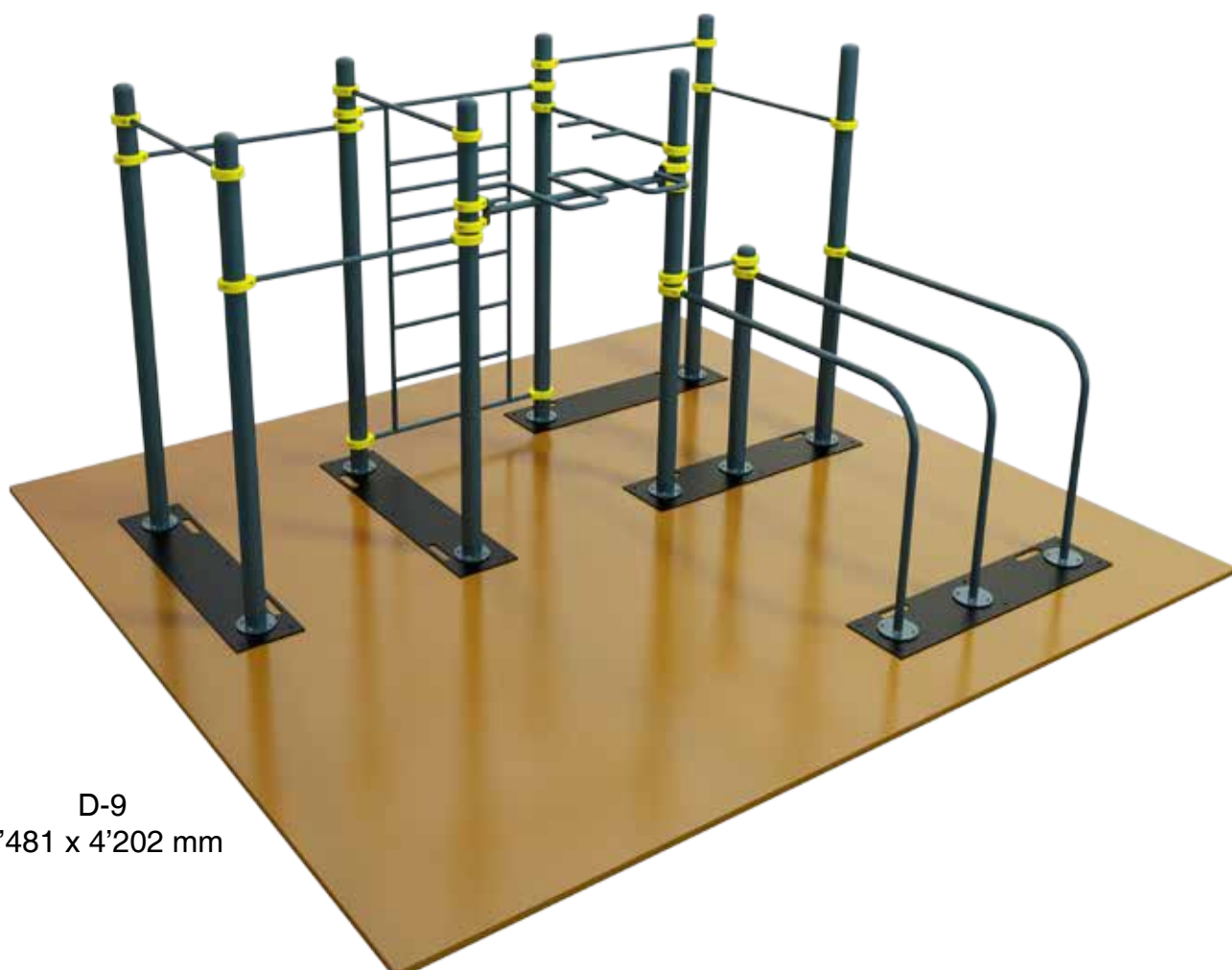

D-9  
3'481 x 4'202 mm

# WORKOUT

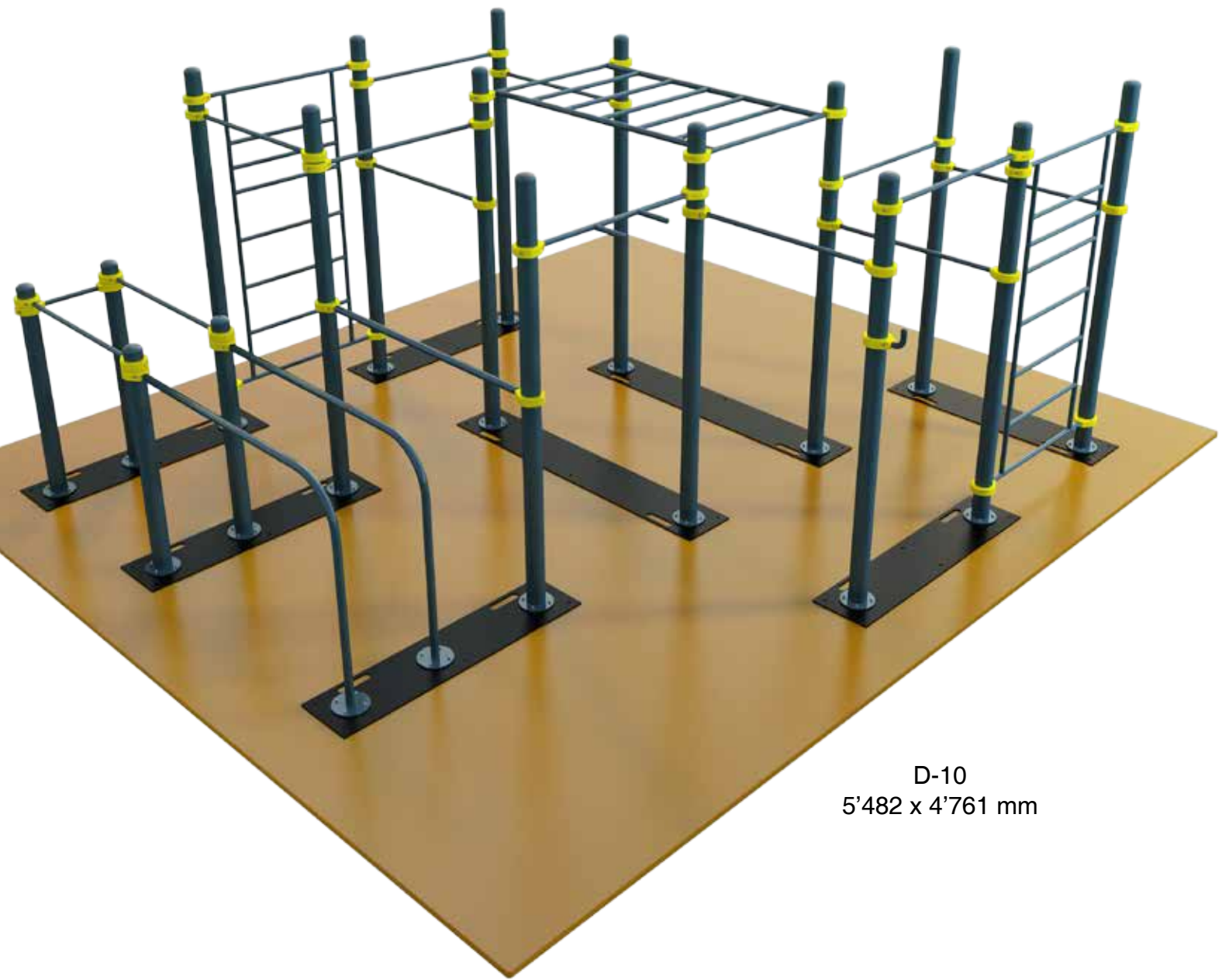

D-10  
5'482 x 4'761 mm

**Série Parkour**  
**Modules de Parkour à sceller**  
**dans des socles en béton**

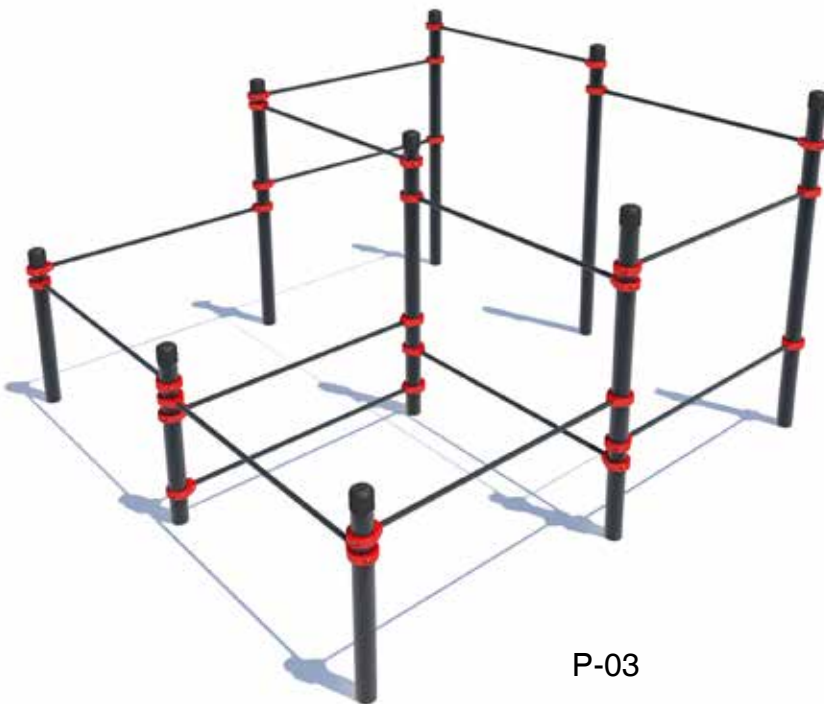
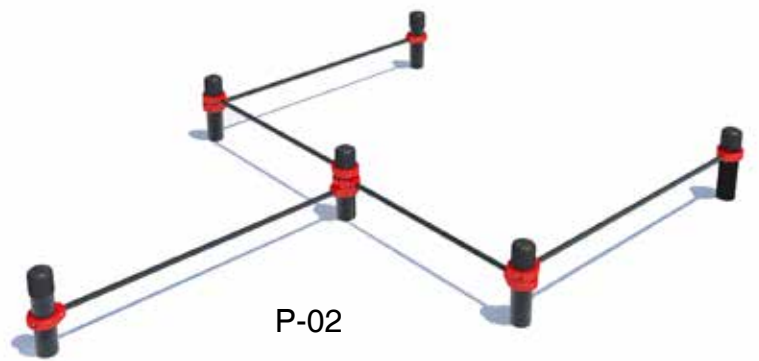
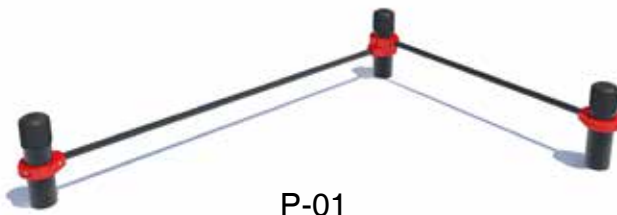

# PARKOUR

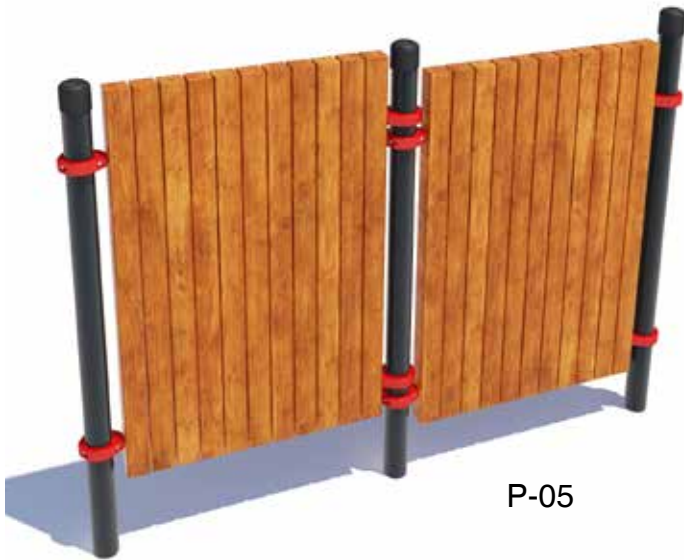

P-05

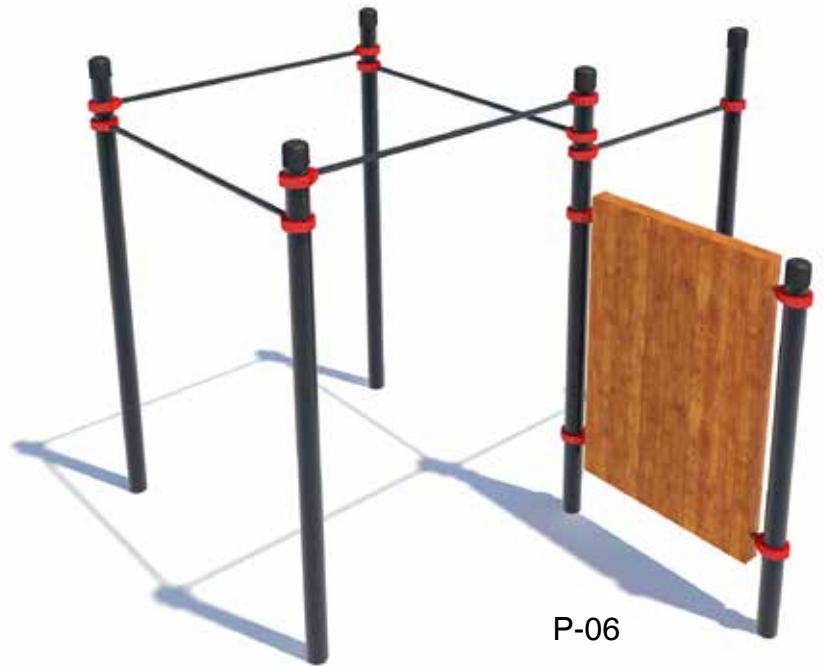

P-06



P-07

**Série Parkour**  
**Modules de Parkour à sceller**  
**dans des socles en béton**

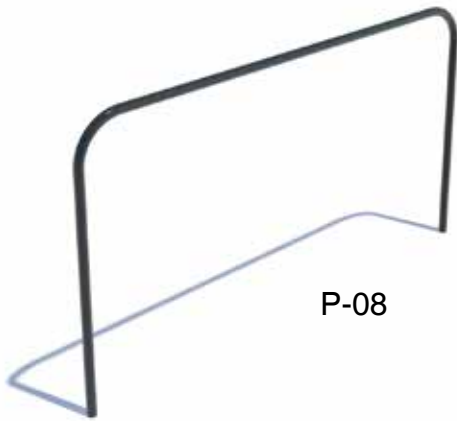

P-08

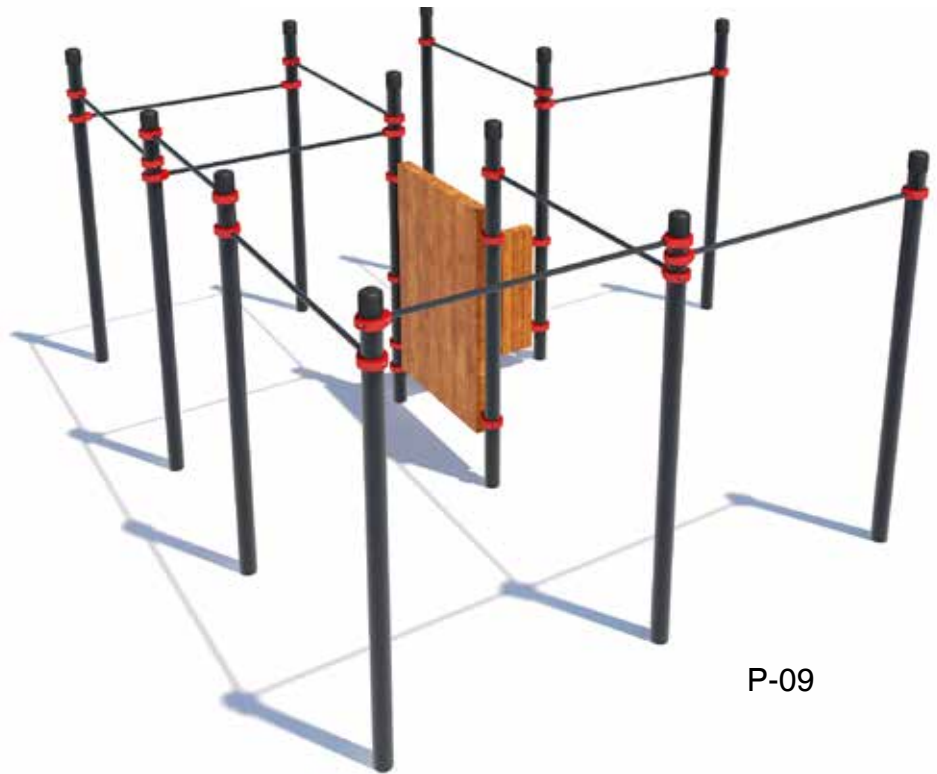

P-09

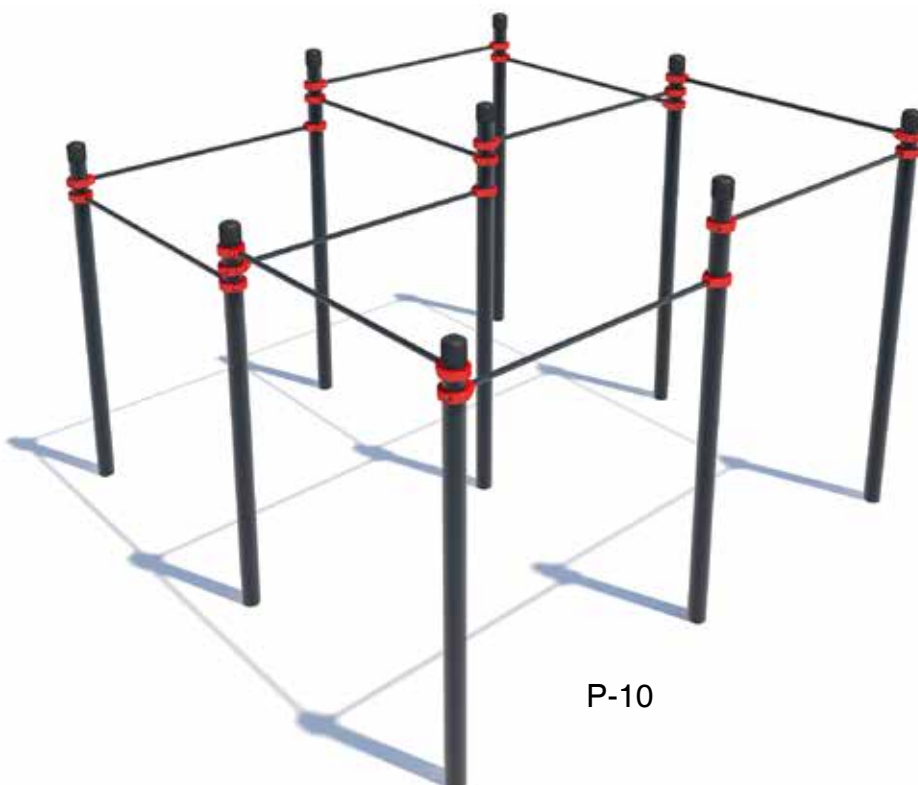

P-10

# PARKOUR

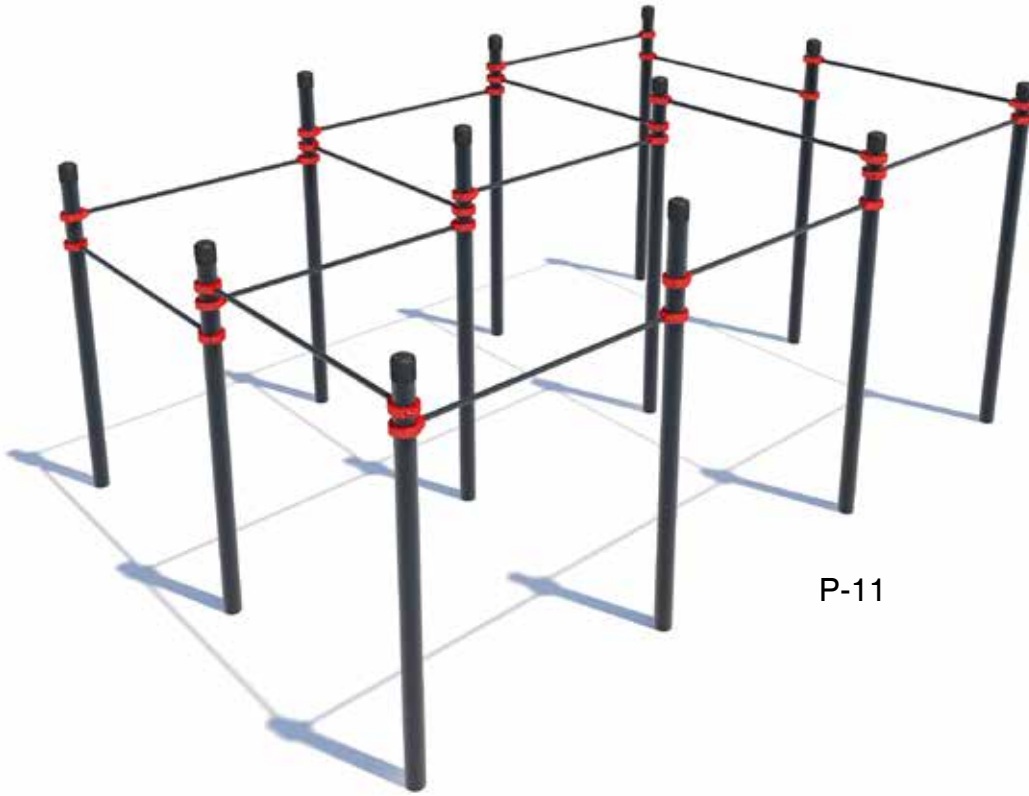

P-11

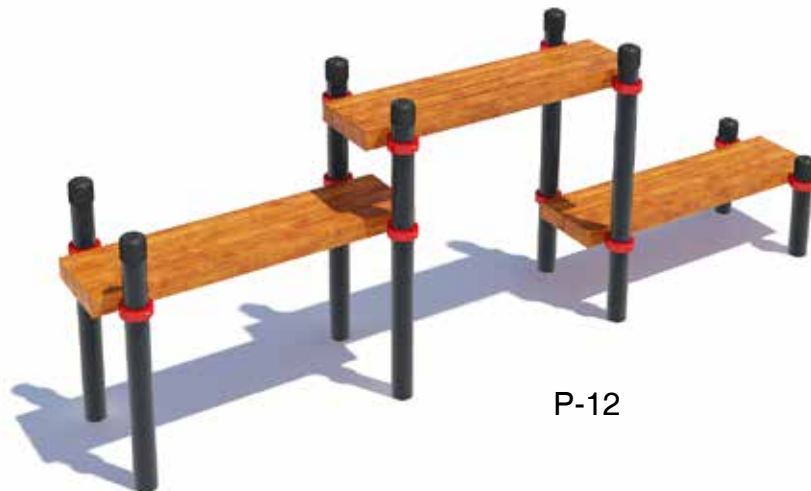

P-12

#### TECHICAL PART

Column\*-steel tube with a diameter of 108 mm, thickness of wall not less than 3.2 mm. Crossbar\*\*-steel tube with a diameter of 34 mm, thickness of wall not less than 3.2 mm On crossbar ends holes under bolts M10.

Collar \*\*\*- steel collars with holes for crossbars, with possibility for fixation from crank and firm fixation on vertical back column. Collar is tightened with two or more security bolts M10. Bars \*\*\*\*- tube with a diameter of 50 mm.

All vertical back columns have elliptical plugs.



Kenguru equipment clamps are highest technology creation by our company and have a patent No. 126420.



Clamps are equipped with anti-vandalism screws.



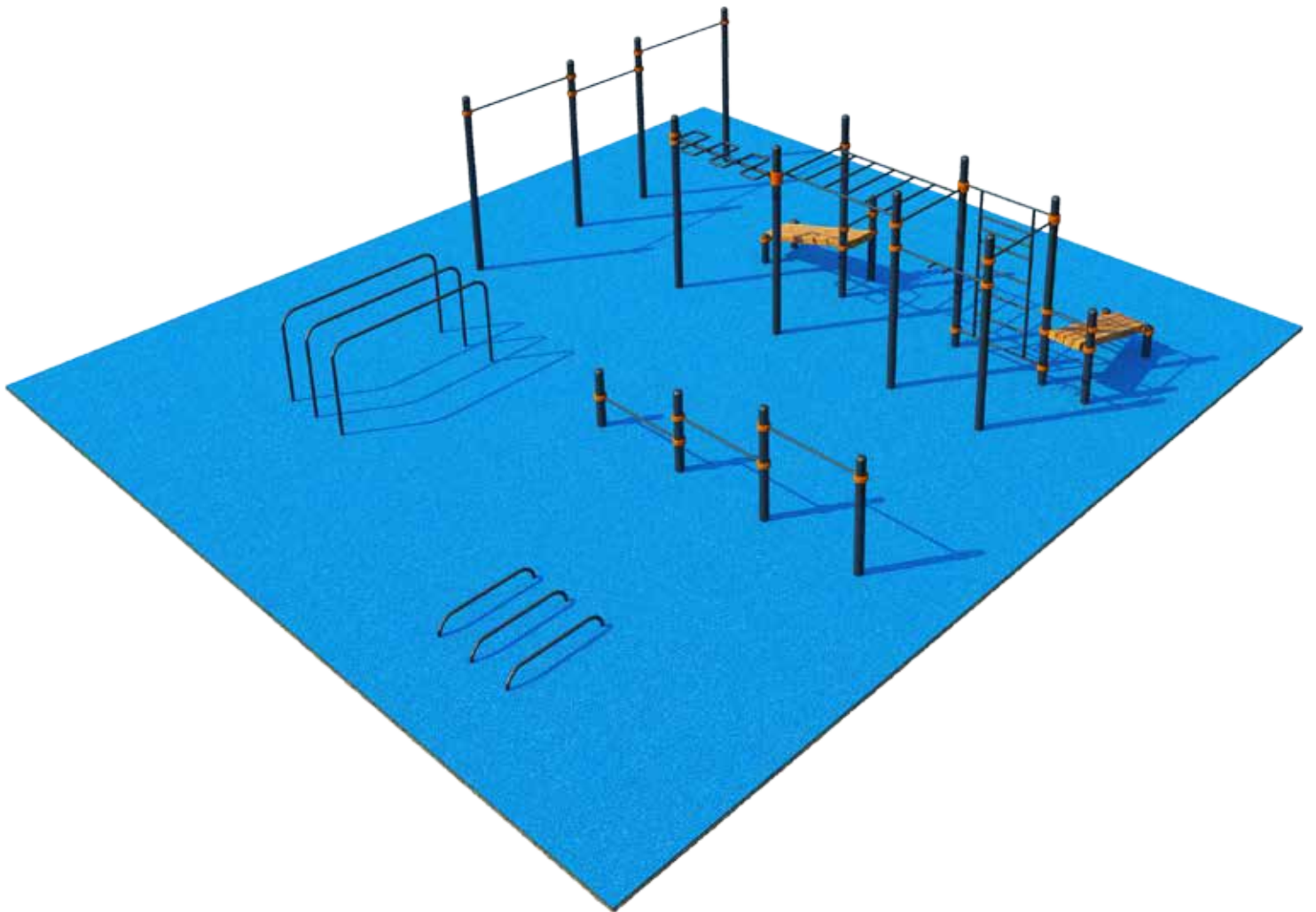

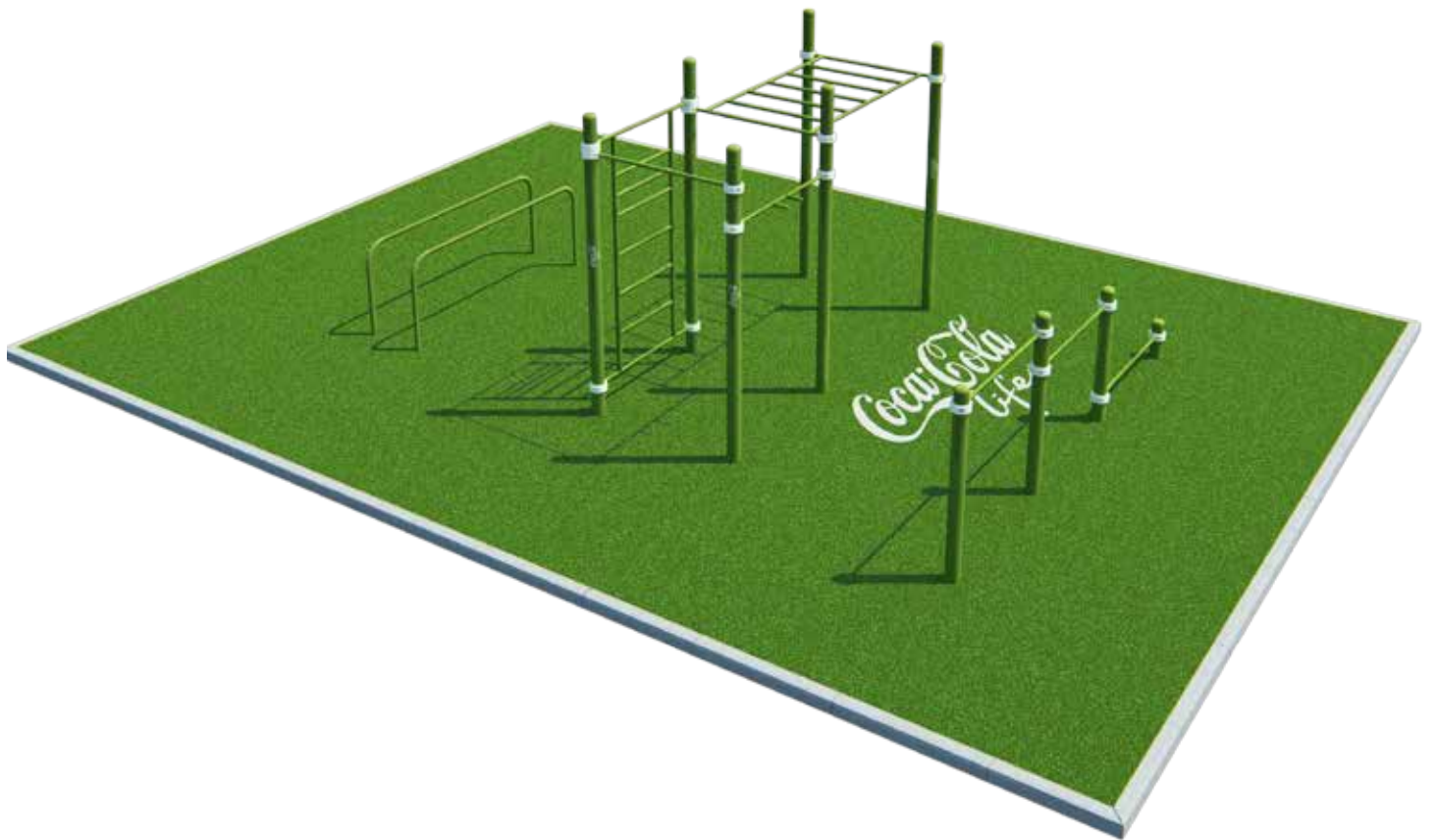
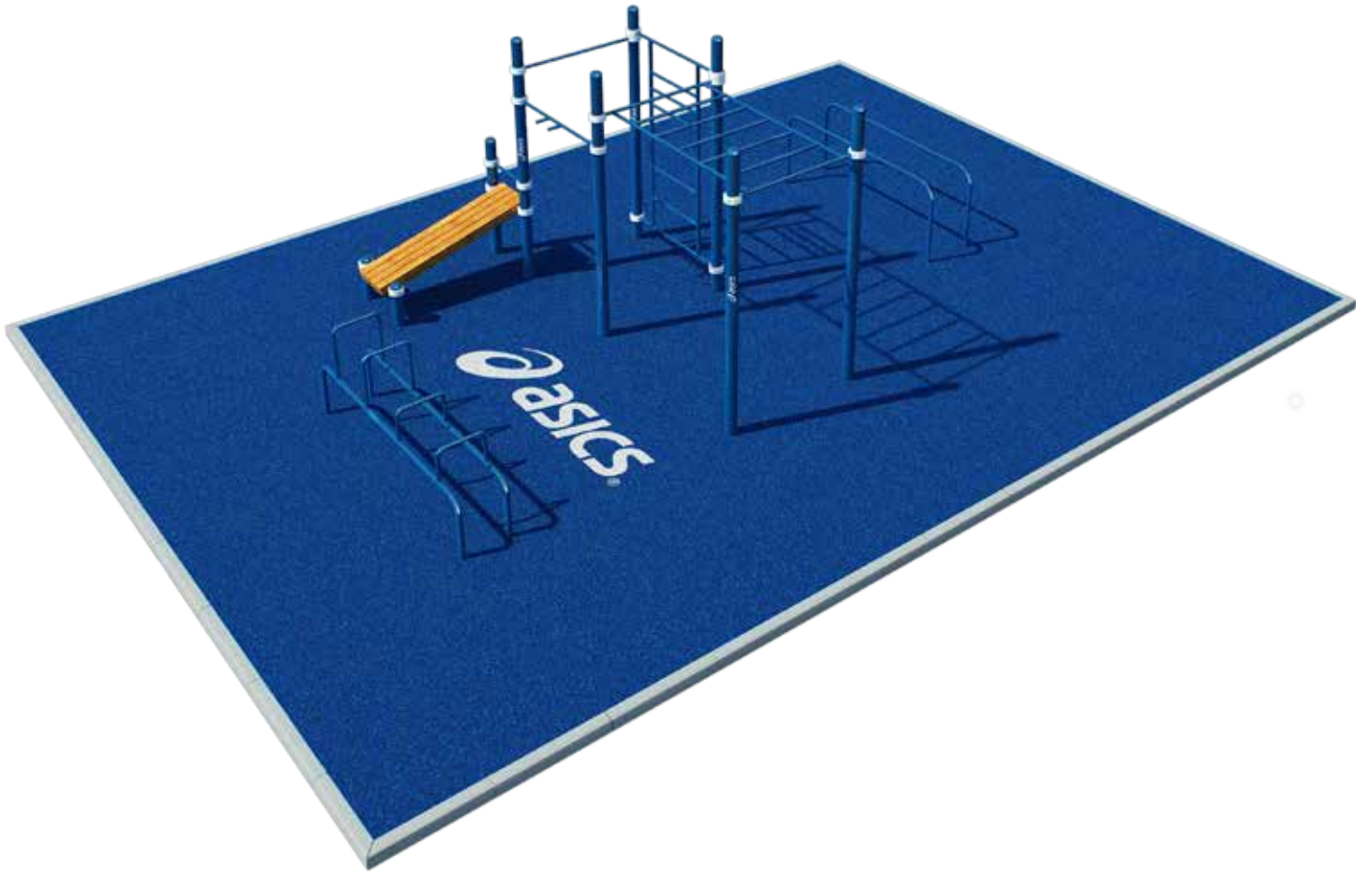





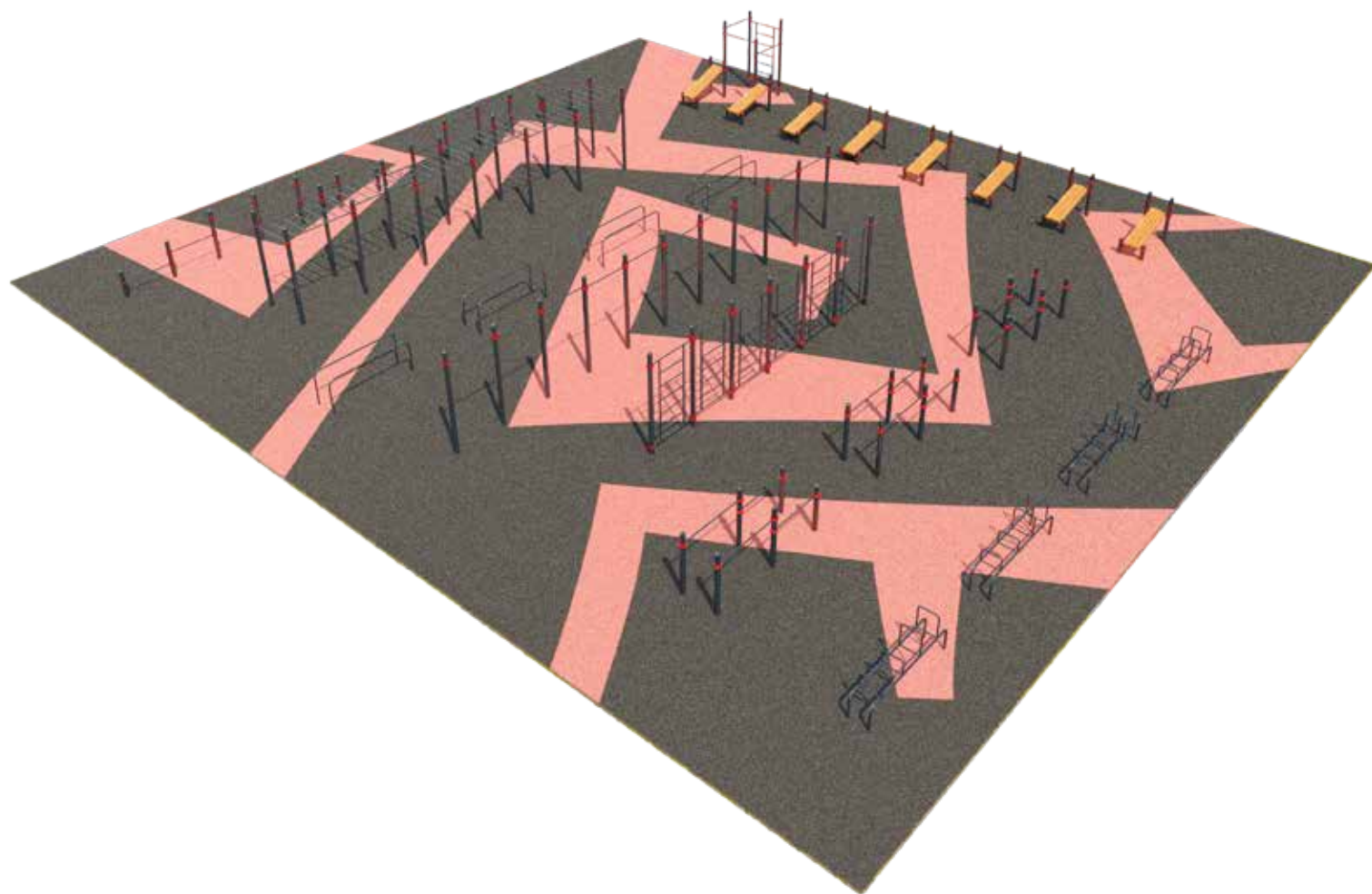
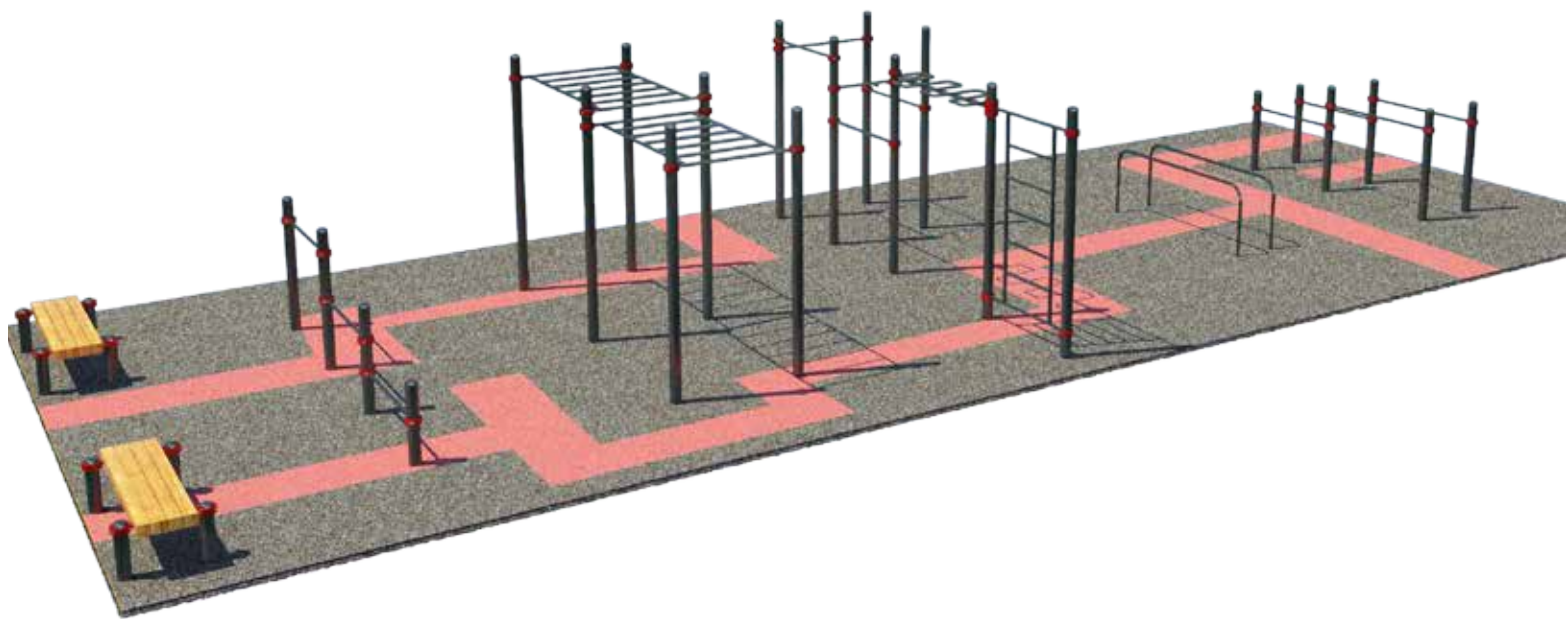



RealSport vous propose un système très complet d'équipement de Street Workout Professionnel. Les éléments sont disponibles en fourniture, en fourniture et pose, ou nous pouvons vous présenter un projet complet selon vos besoins.

N'hésitez pas à nous contacter.

info@realsport.ch  
Tel. 026 402 57 05  
Fax. 026 402 57 06

## Fribourg

Ch.de Combernesse 9  
1728 Rossens  
Tél. 026 402 57 05  
Fax 026 402 57 06

## Vaud

La Veyre d'en Haut D 10  
1806 St-Légier  
Tél. 021 921 27 19  
Fax 021 921 27 29

## Genève

Route de Bossey 68  
1256 Troinex  
Tél. 022 899 11 45  
Fax 022 899 11 49

## Valais

Ch. du Rhône 133  
1926 Fully  
Tél. 027 746 36 48  
Fax 027 746 37 54

## Zürich

Mühlestrasse 27  
8623 Wetzikon  
Tél. 044 930 43 53

**realsport**

info@realsport.ch  
www.realsport.ch



L'ensemble des spécifications  
présentées dans ce document  
peuvent être modifiées sans  
préavis.

Doc. 7.2.4.10  
vers 18.0 ©RS

